

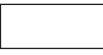



# TRODAT PRINTY LINE\_OVERLAY

4850   
10 NOV 2009

4908  Max. 14 x 6 mm  
 $\frac{1}{4}'' \times \frac{9}{16}''$  ◆ 6/4908

4911  Max. 37 x 13 mm •  $\frac{1}{2}'' \times \frac{17}{16}''$   
◆ 6/4911

4921  Max. 11 x 11 mm  
 $\frac{7}{16}'' \times \frac{7}{16}''$  ◆ 6/4921

Max. 24 x 4 mm •  $\frac{3}{16}'' \times \frac{15}{16}''$  ◆ 6/4850

4910  Max. 25 x 8 mm  
 $\frac{5}{16}'' \times 1''$  ◆ 6/4910

4813  10 NOV 2009  
Max. 25 x 8 mm •  $\frac{5}{16}'' \times 1''$  ◆ 6/4817

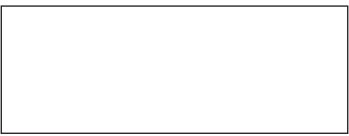
4912  Max. 46 x 17 mm •  $\frac{5}{8}'' \times 1\frac{13}{16}''$  ◆ 6/4912

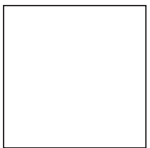
4922  Max. 19 x 19 mm  
 $\frac{3}{4}'' \times \frac{3}{4}''$  ◆ 6/4922

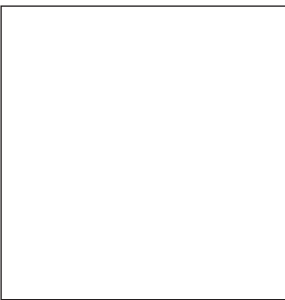
4924  Max. 39 x 39 mm •  $1\frac{1}{2}'' \times 1\frac{1}{2}''$   
◆ 6/4924

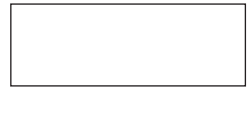
4750, 4941 (4760)  Max. 40 x 23 mm •  $\frac{5}{16}'' \times 1\frac{9}{16}''$   
◆ 6/4750

4913  Max. 57 x 21 mm •  $\frac{13}{16}'' \times 2\frac{1}{4}''$  ◆ 6/4913

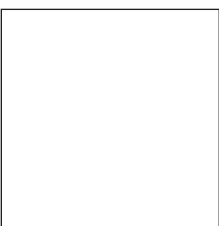
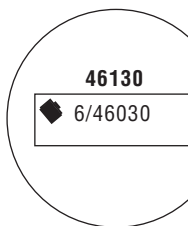
4923  Max. 29 x 29 mm •  $1\frac{1}{8}'' \times 1\frac{1}{8}''$  ◆ 6/4923  
46030  ◆ 6/46030  
◆ 6/46030  
Ø 29 mm •  $1\frac{1}{8}''$

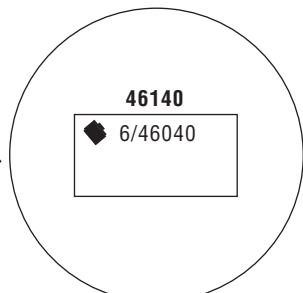
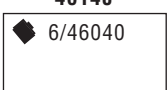
46040  ◆ 6/46040  
46140  ◆ 6/46040  
◆ 6/46040  
Ø 39 mm •  $1\frac{1}{2}''$

4915  Max. 69 x 24 mm •  $\frac{15}{16}'' \times 2\frac{11}{16}''$  ◆ 6/4915

4928  Max. 59 x 32 mm •  $1\frac{1}{4}'' \times 2\frac{5}{16}''$   
◆ 6/4928

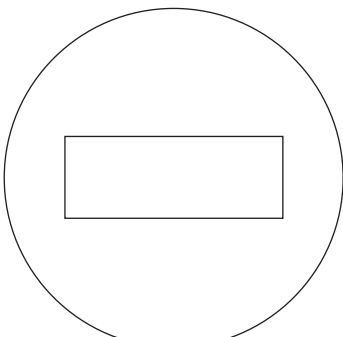

46145  ◆ 6/46145  
Ø 44 mm •  $1\frac{3}{4}''$  ◆ 6/46145

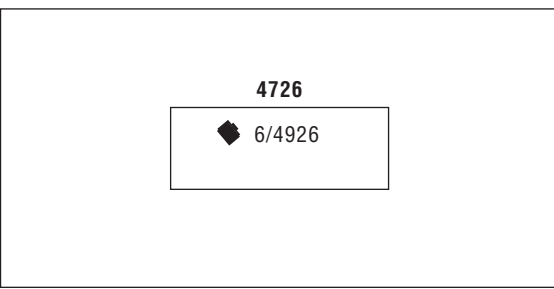
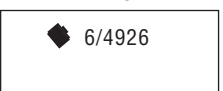
4916  Max. 69 x 9 mm •  $\frac{5}{16}'' \times 2\frac{11}{16}''$  ◆ 6/4916

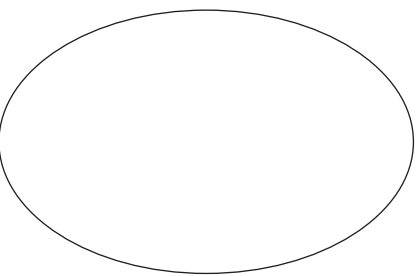
4926  4726  ◆ 6/4926  
Max. 74 x 37 mm •  $1\frac{7}{16}'' \times 2\frac{15}{16}''$  ◆ 6/4926

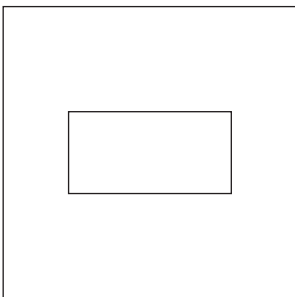
44055  Max. 54 x 34 mm •  $1\frac{3}{8}'' \times 2\frac{1}{8}''$  ◆ 6/44055

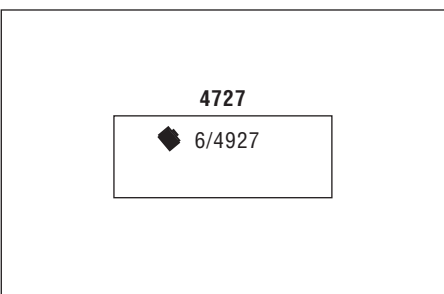
4724  Max. 39 x 39 mm •  $1\frac{1}{2}'' \times 1\frac{1}{2}''$   
◆ 6/4924

4927  4727  ◆ 6/4927  
Max. 59 x 39 mm •  $1\frac{1}{2}'' \times 2\frac{5}{16}''$  ◆ 6/4927

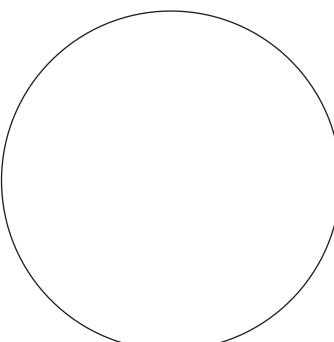
46045  Ø 44 mm •  $1\frac{3}{4}''$  ◆ 6/46145

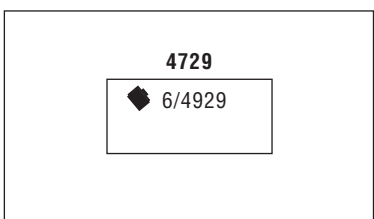
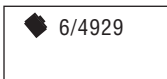
4929  4729  ◆ 6/4929  
Max. 49 x 29 mm •  $1\frac{1}{8}'' \times 1\frac{15}{16}''$  ◆ 6/4929

**trodat**®

